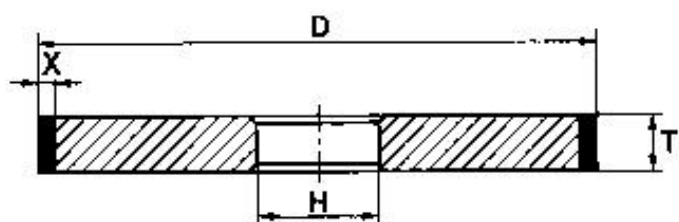
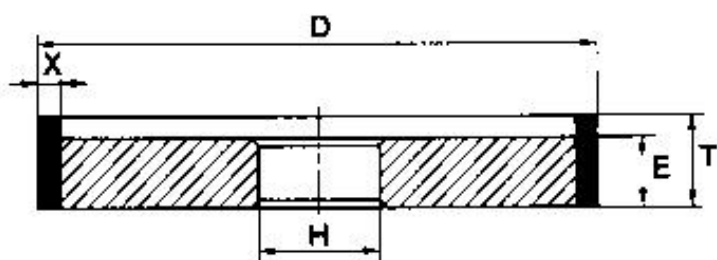
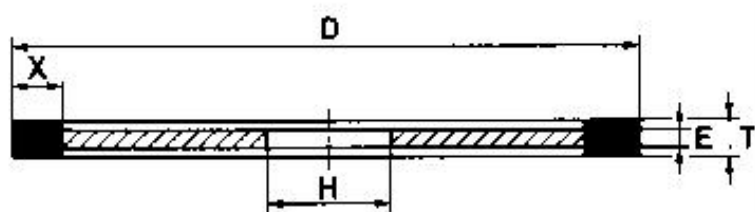

1A1

D	T	H	X

1A1P

D	T	H	X	E

1A1R

D	T	H	X	E

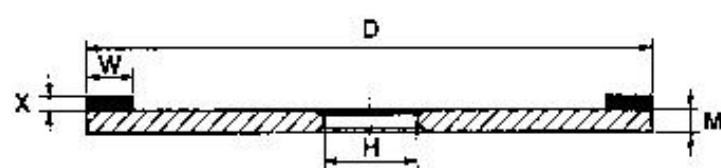
1A2

D	M	H	X	W

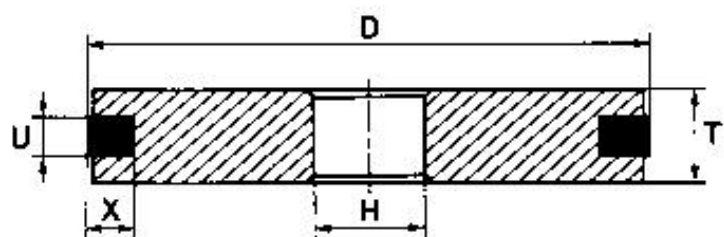
1A6Q

D	T	H	U	X

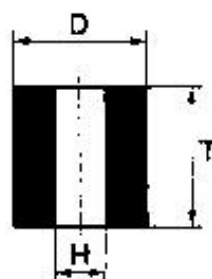
1A8

D	T	H

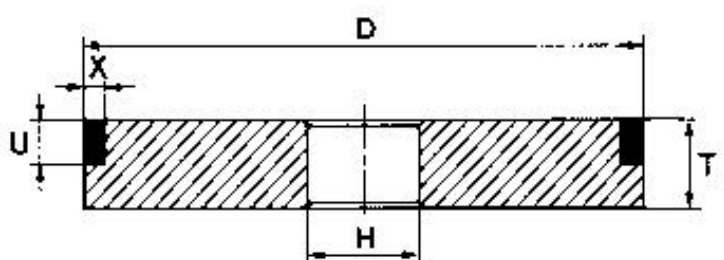
1A9

D	T	H	U	X

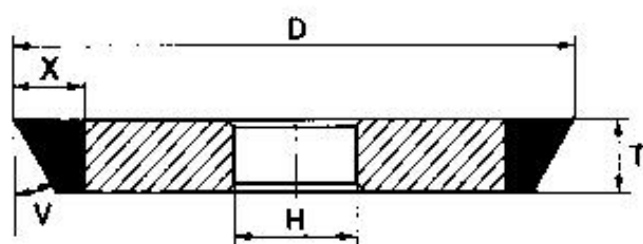
1B1

D	T	H	V	X

1CH1

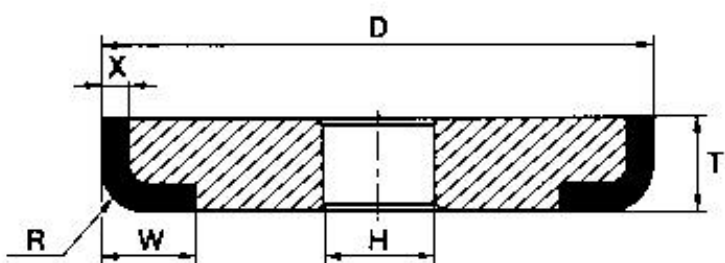

D	T	H	R	X	W

1CH3Y

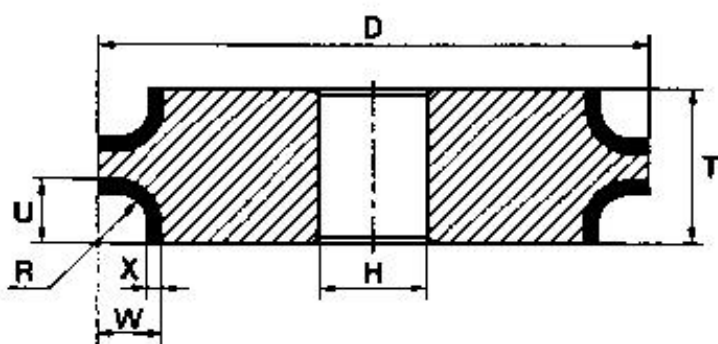

D	T	H	U	W	X	R

1CH9

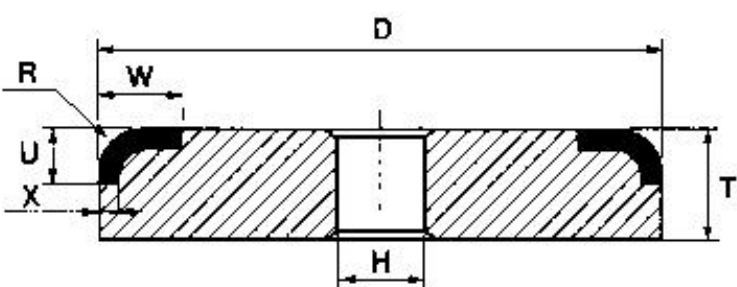

D	T	H	U	W	X	R

1CH9Y

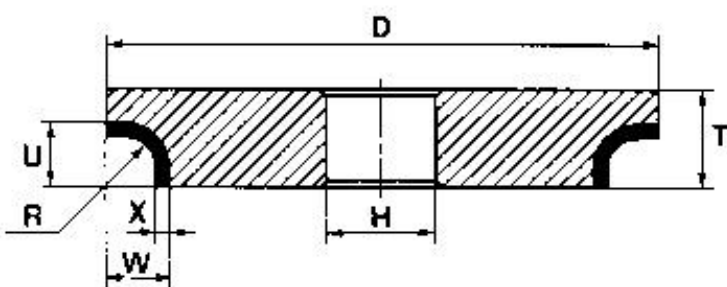

D	T	H	U	W	X	R

1C1

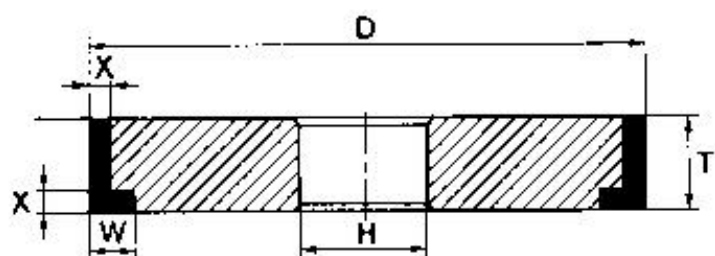

D	T	H	W	X

1DD1

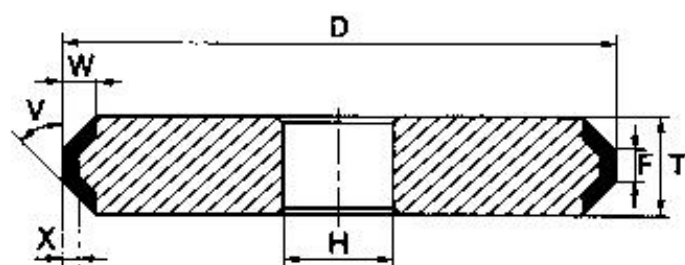

D	T	H	V	X	F	W

1D1

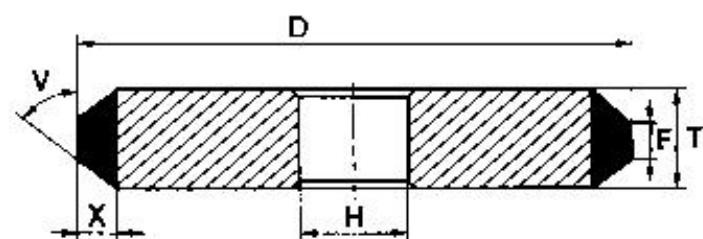

D	T	H	V	X	F

1EE1

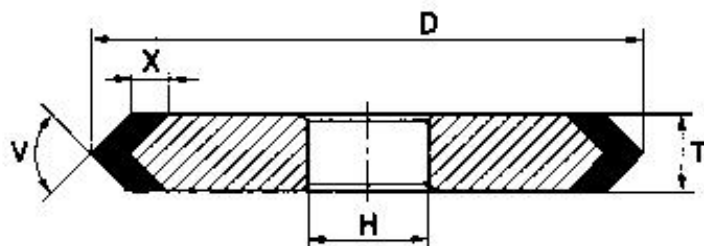

D	T	H	V	X

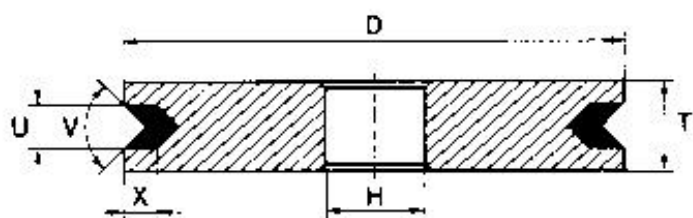
1EE6Y

D	T	H	V	U	X

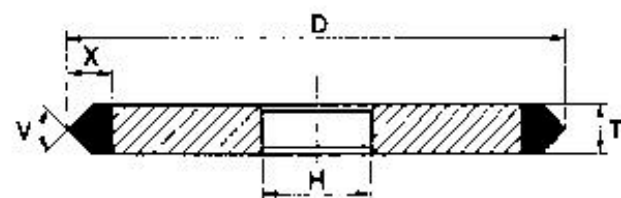
1E1

D	T	H	V	X

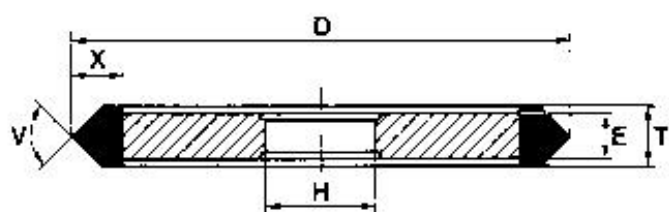
1E1R

D	T	H	V	X	E

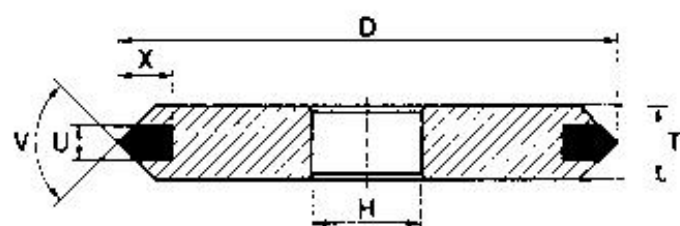
1E6Q

D	T	H	V	U	X

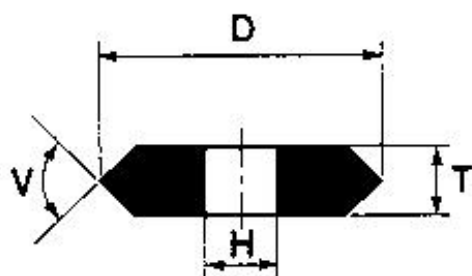
1E8

D	T	H	V

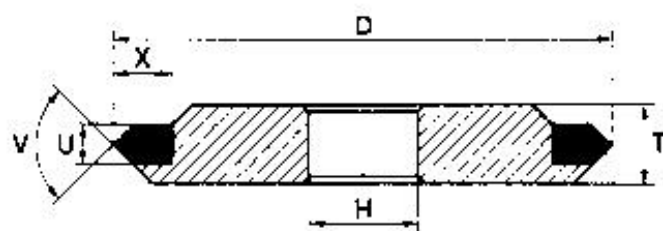
1E9

D	T	H	V	U	X

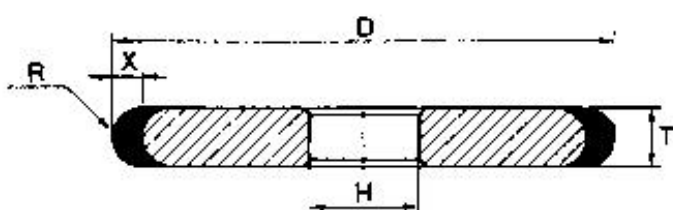
1FF1

D	T	H	R	X

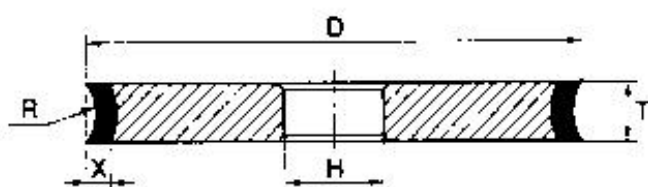
1FF1V

D	T	H	R	X

1FF6Y

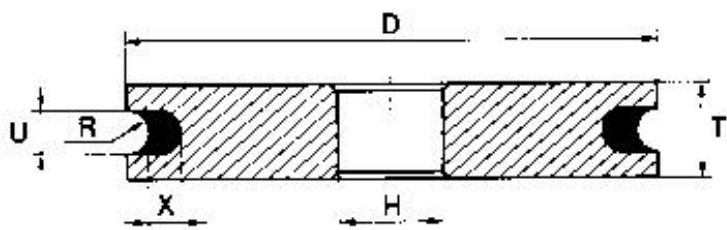

D	T	H	R	U	X

1F1

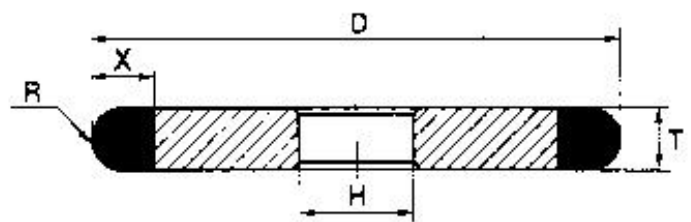

D	T	H	R	X

1F1V

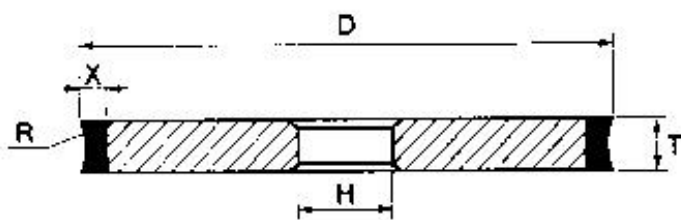

D	T	H	R	X

1F8

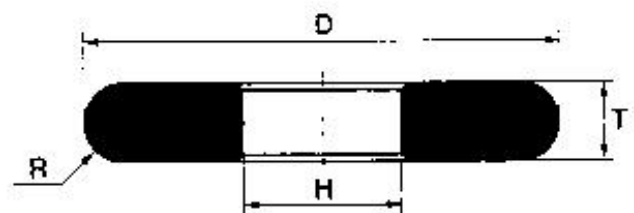

D	T	H	R

1H9Y

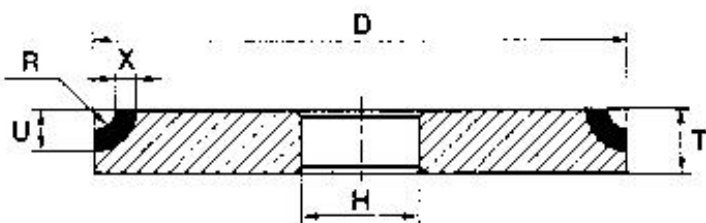

D	T	H	R	U	X

1K1

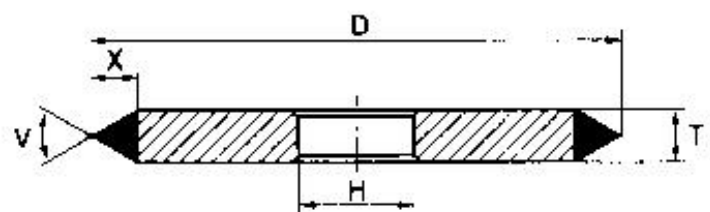

D	T	H	V	X

1LL1

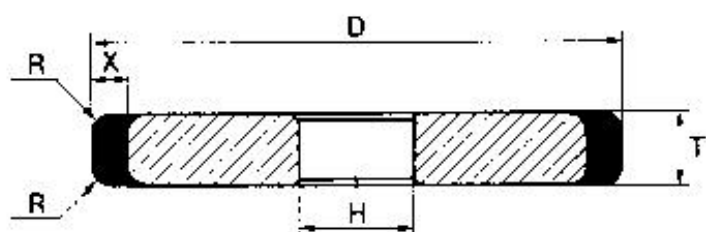

D	T	H	R	X

1L1

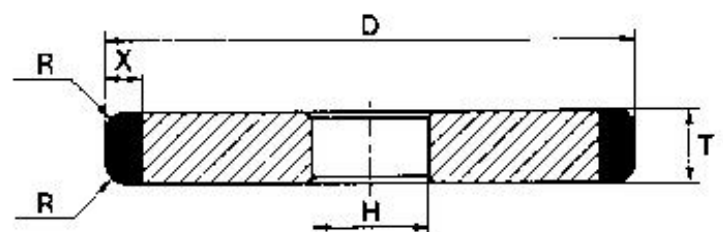

D	T	H	R	X

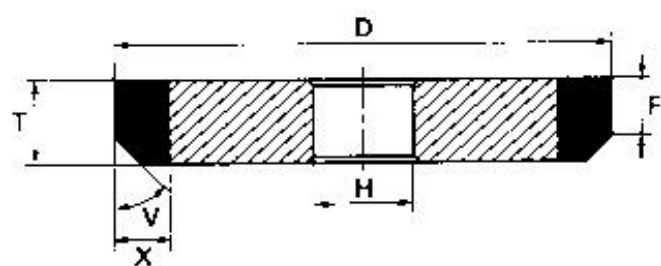
1M1

D	T	H	V	X	F

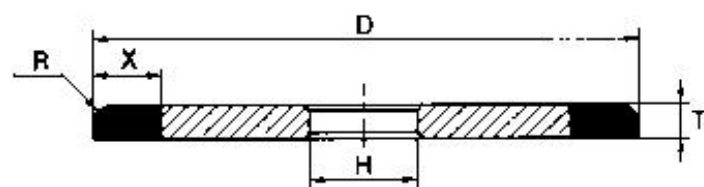
1Q1

D	T	H	R	X

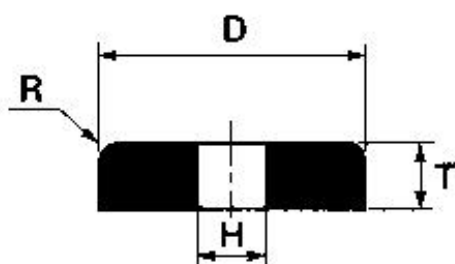
1Q8

D	T	H	R

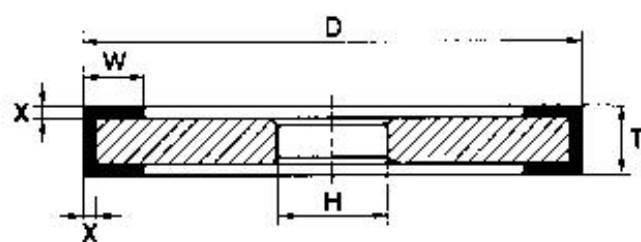
1U1

D	T	H	W	X

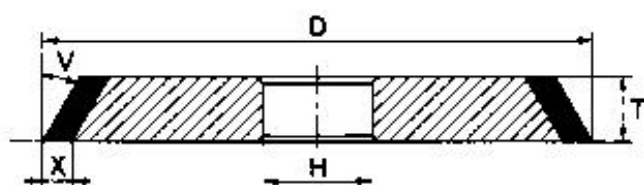
1V1

D	T	H	V	X

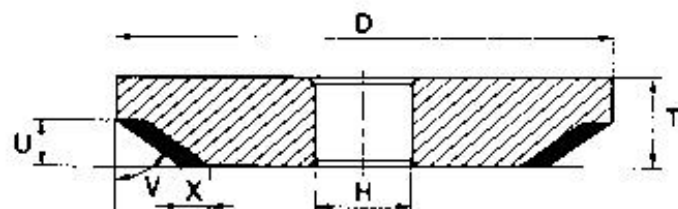
1V9

D	T	H	V	U	X

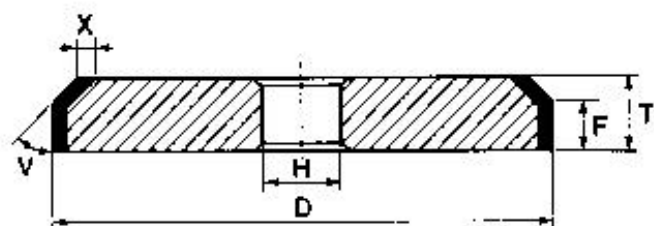
1Y1

D	T	H	V	X	F

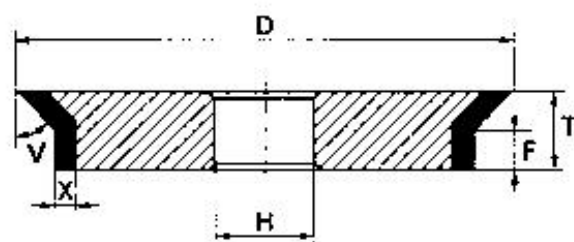
1Y1V

D	T	H	V	X	F

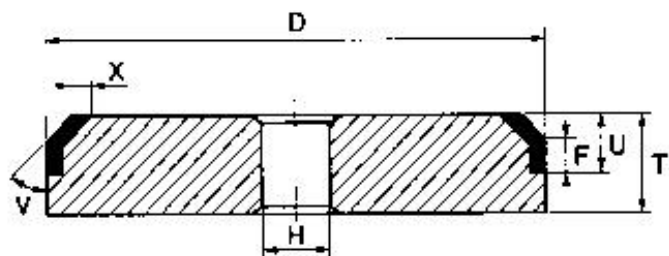
1Y9

D	T	H	V	U	X	F
---	---	---	---	---	---	---

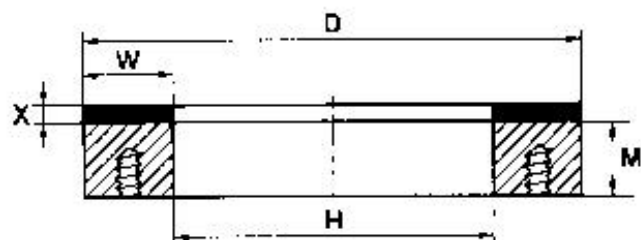
2A2T

D	M	H	W	X
---	---	---	---	---

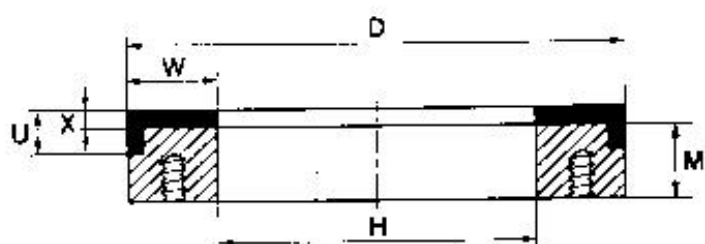
2C9T

D	M	H	W	U	X
---	---	---	---	---	---

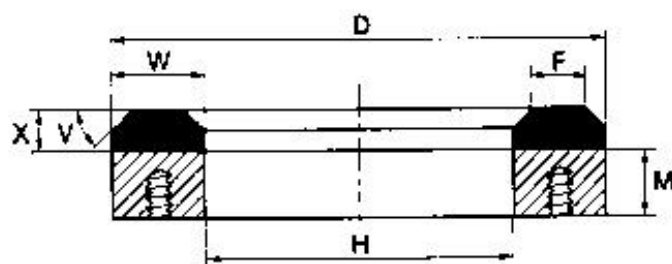
2ER2T

D	M	H	W	V	X	F
---	---	---	---	---	---	---

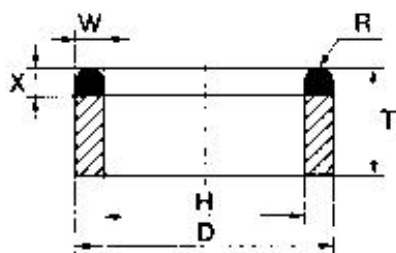
2F2

D	T	H	R	X	W
---	---	---	---	---	---

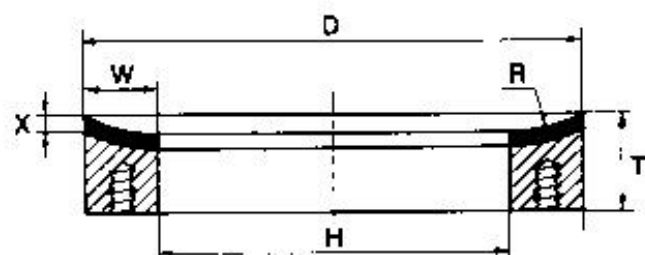
2P4T

D	T	H	W	R	X
---	---	---	---	---	---

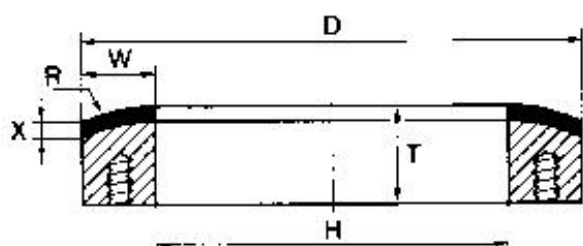
2P5T

D	T	H	W	R	X
---	---	---	---	---	---

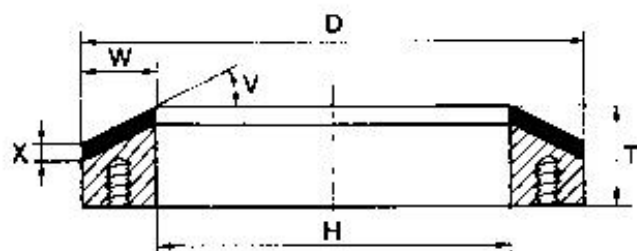
2V5T

D	T	H	W	V	X
---	---	---	---	---	---

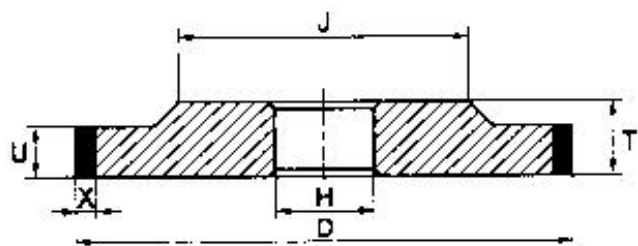
3A1

D	U	H	X	T	J

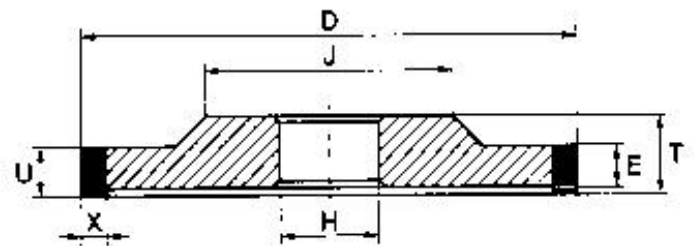
3A1P

D	U	H	X	E	T	J

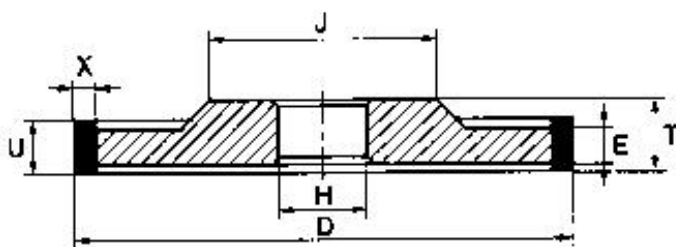
3A1R

D	U	H	X	E	T	J

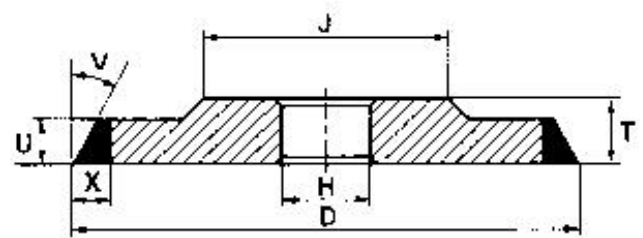
3B1

D	U	H	V	X	T	J

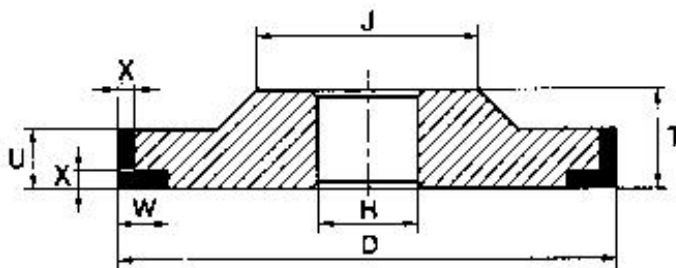
3C9

D	U	H	W	X	T	J

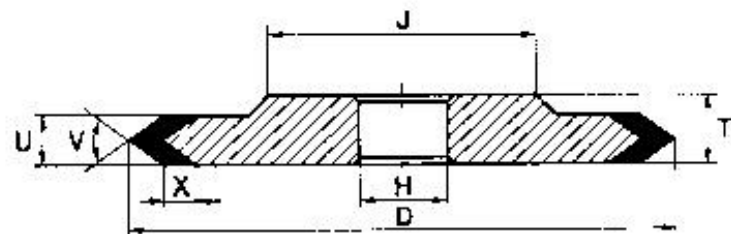
3EE1

D	U	H	V	X	T	J

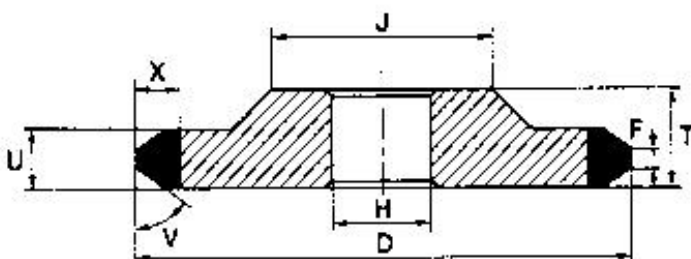
3ER1

D	U	H	V	F	X	T	J

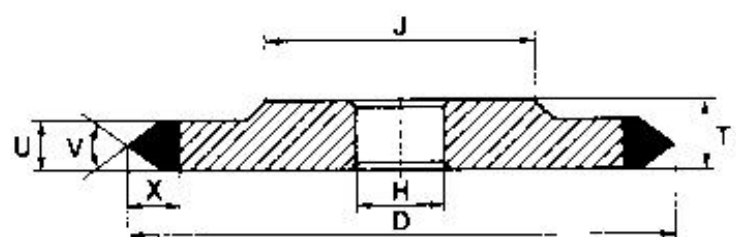
3E1

D	U	H	V	X	T	J

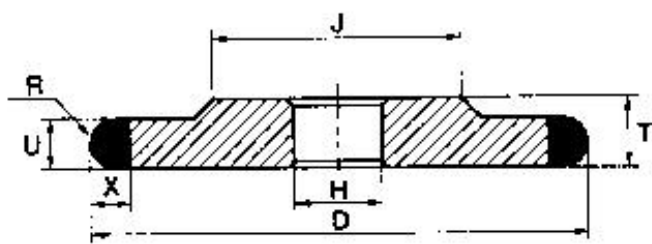
3F1

D	U	H	R	X	T	J
---	---	---	---	---	---	---

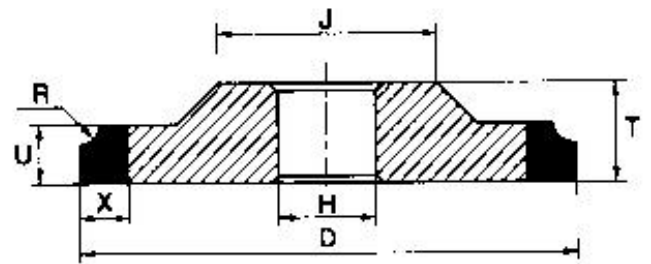
3G9

D	U	H	R	X	T	J
---	---	---	---	---	---	---

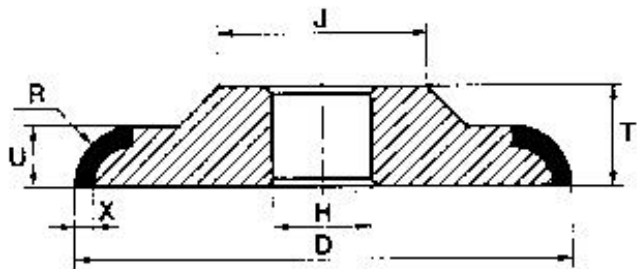
3H9

D	U	H	R	X	T	J
---	---	---	---	---	---	---

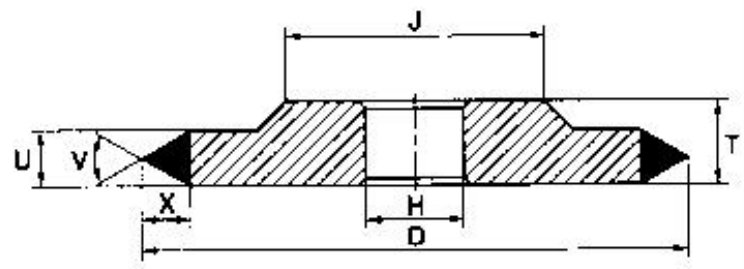
3K1

D	U	H	V	X	T	J
---	---	---	---	---	---	---

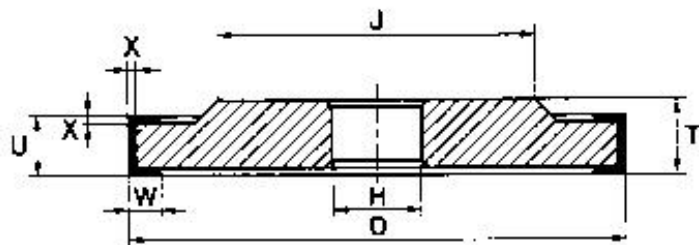
3U1

D	U	H	W	X	T	J
---	---	---	---	---	---	---

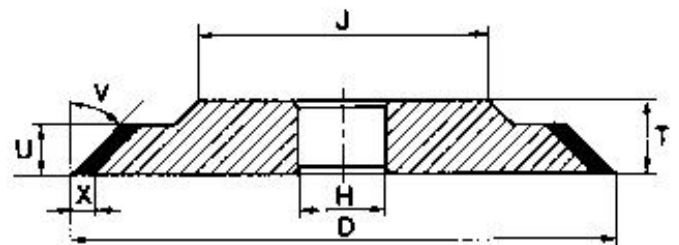
3V1

D	U	H	V	X	T	J
---	---	---	---	---	---	---

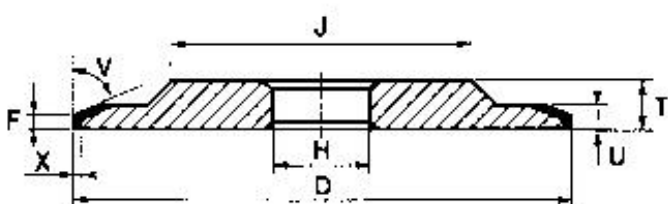
3Y1

D	U	H	V	X	F	T	J
---	---	---	---	---	---	---	---

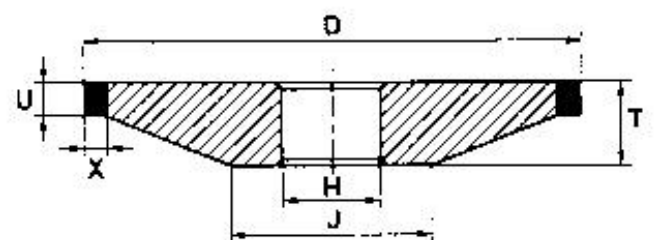
4A1

D	U	H	X	T	J
---	---	---	---	---	---

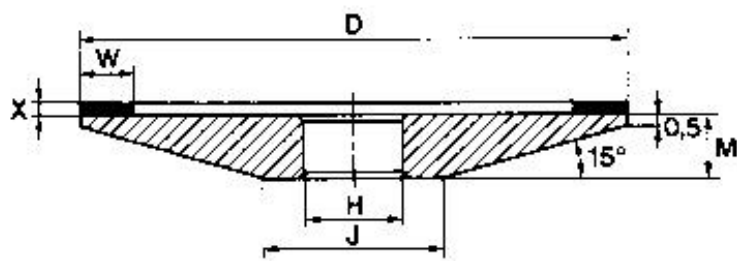
4A2

D	M	H	W	X	J

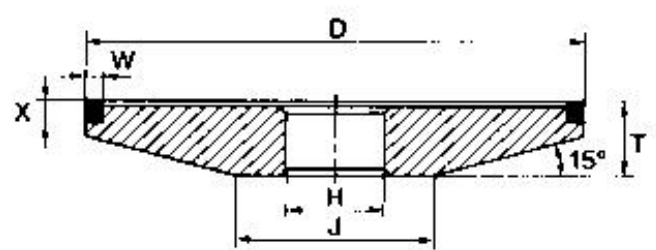
4A9

D	T	H	W	X	J

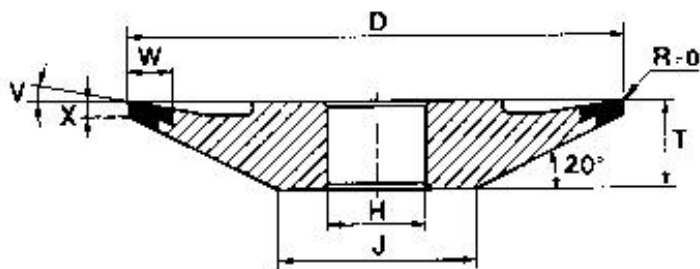
4BT9

D	T	H	W	V	R	X	J

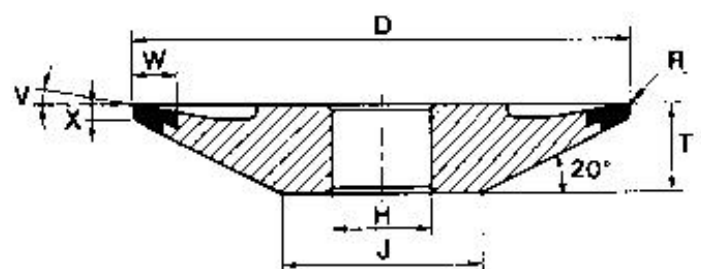
4BT9

D	T	H	W	V	R	X	J

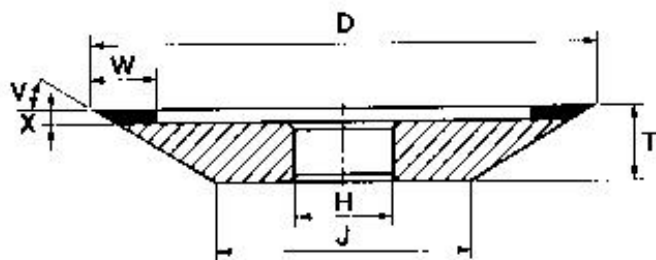
4B2

D	T	H	W	V	X	J

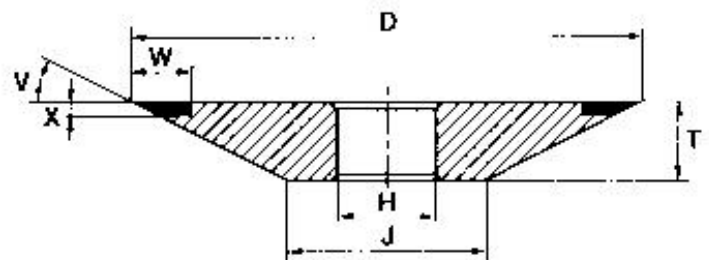
4B9

D	T	H	W	V	X	J

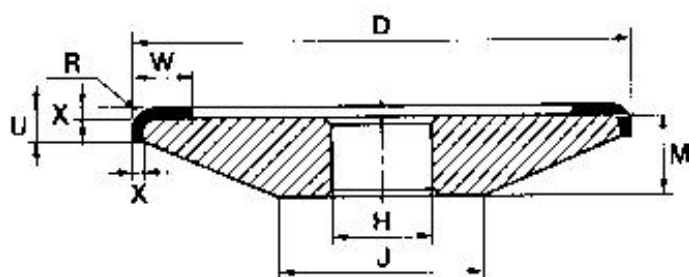
4CH9

D	M	H	W	R	X	U	J

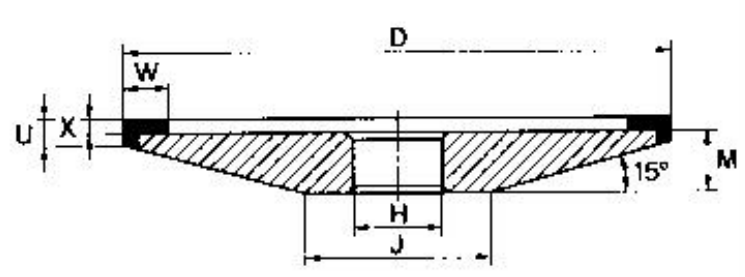
4C9

D	M	H	W	X	U	J

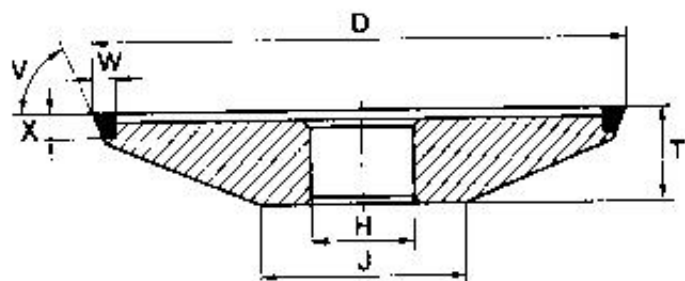
4E19

D T H W V X J

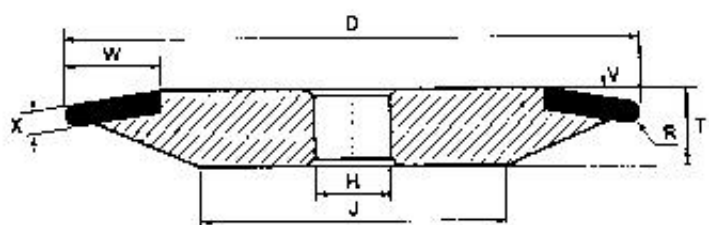
4F5

D T H W R X V J

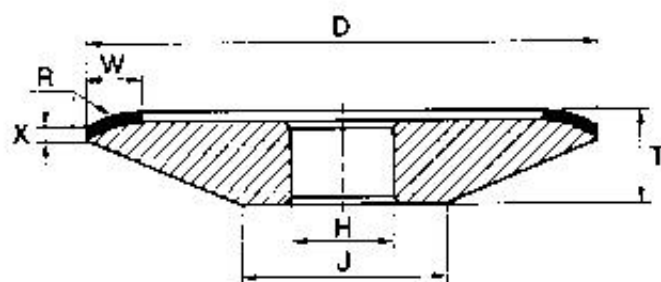
4P5

D T H W R X J

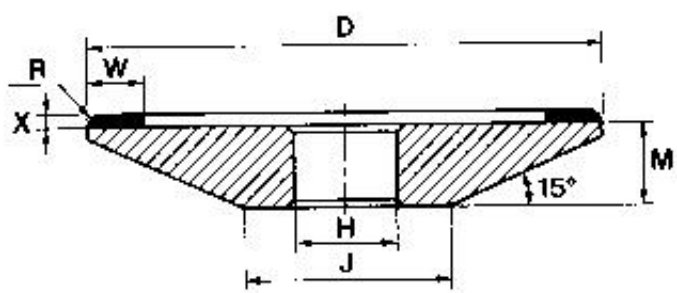
4Q2

D M H W R X J

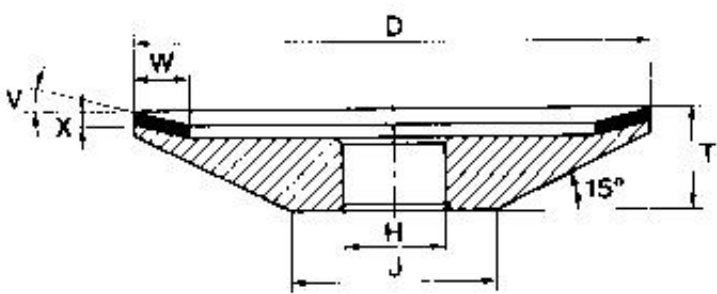
4V4

D T H W V X J

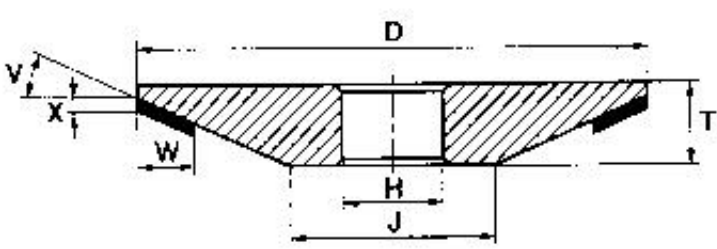
4V5

D T H W V X J

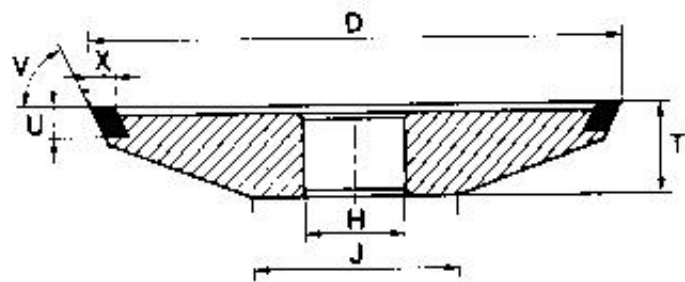
4V9

D T H V X U J

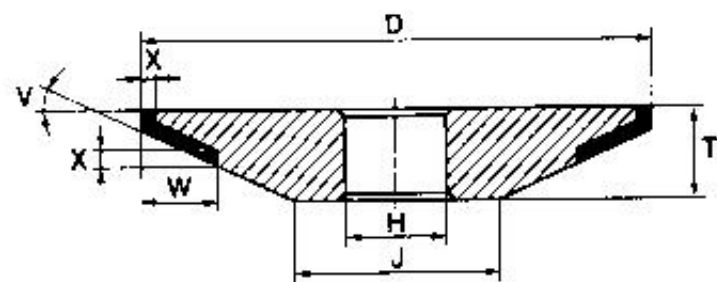
4Y5

D T H W V X J

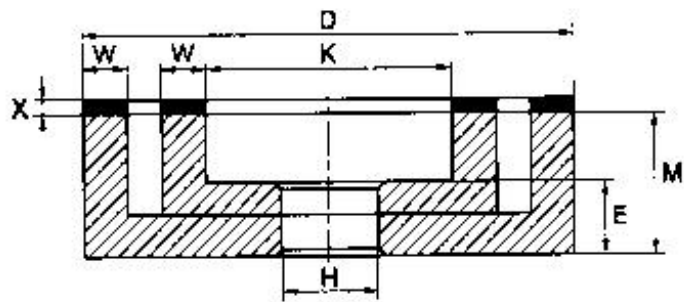
6AA2

D	M	H	W	X	K	E
---	---	---	---	---	---	---

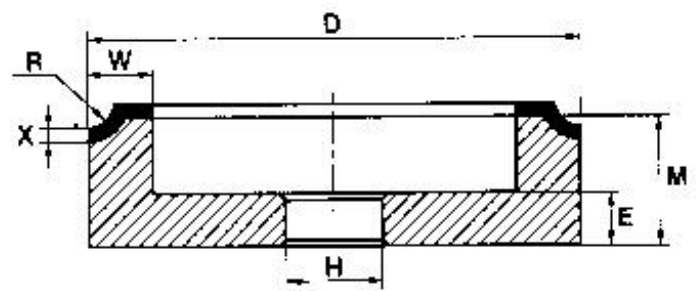
6AH2

D	M	H	W	R	X	E
---	---	---	---	---	---	---

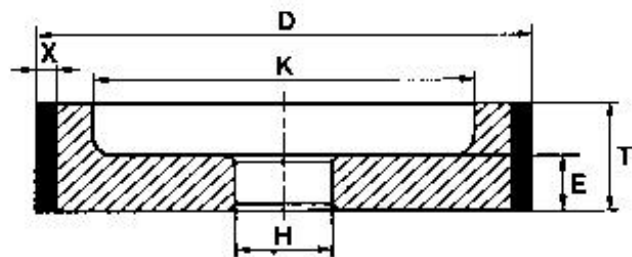
6A1

D	T	H	X	K	E
---	---	---	---	---	---

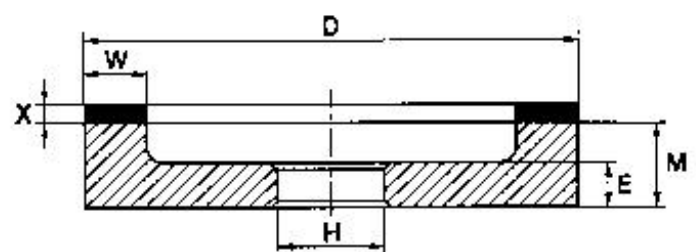
6A2

D	M	H	W	X	E
---	---	---	---	---	---

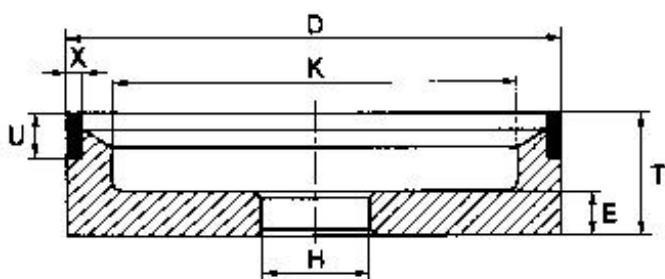
6A9

D	T	H	X	U	K	E
---	---	---	---	---	---	---

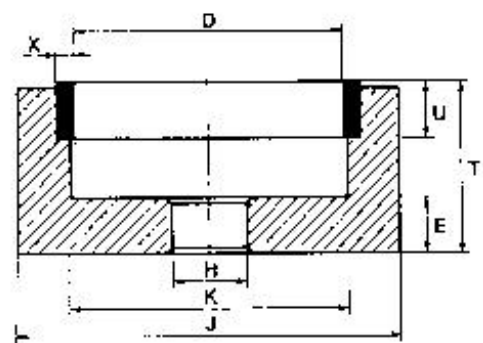
6A10

D	T	H	X	U	J	K	E
---	---	---	---	---	---	---	---

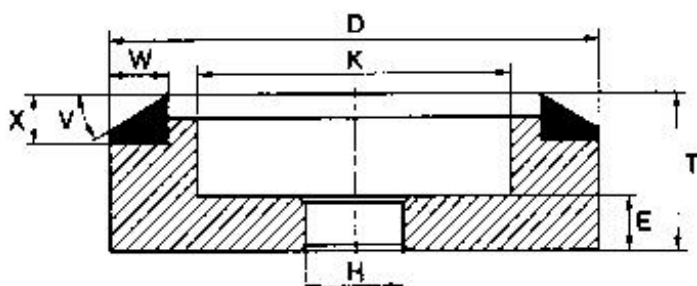
6B9

D	T	H	W	V	X	K	E
---	---	---	---	---	---	---	---

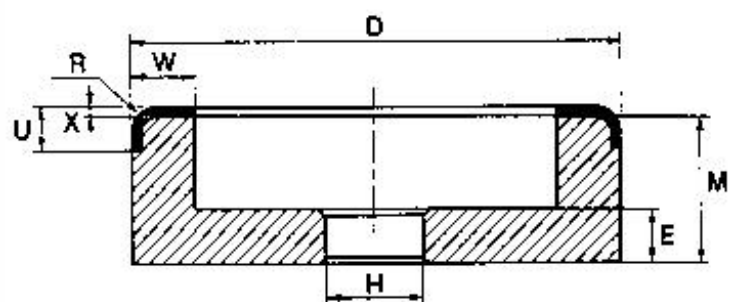
6CH9

D	M	H	W	R	X	U	E
---	---	---	---	---	---	---	---

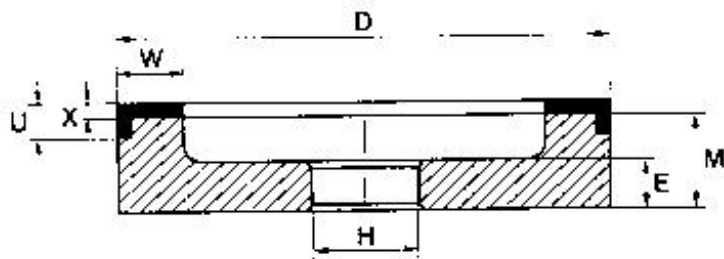
6C9

D M H W U X E

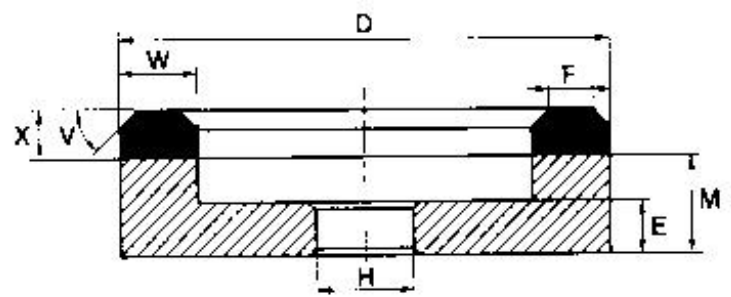
6ER2

D M H W V X F E

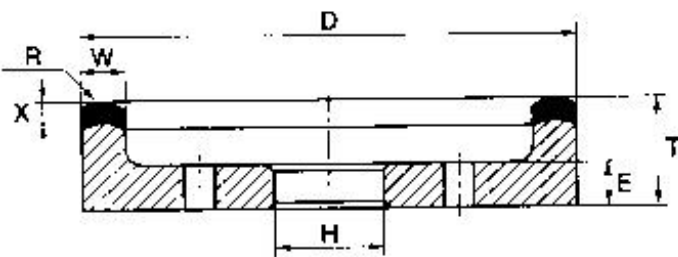
6FF2H

D T H W R X E

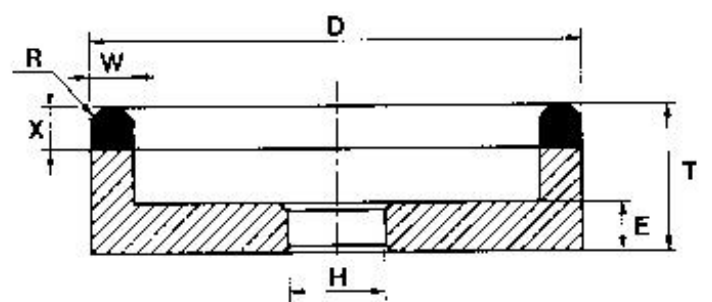
6F2

D T H W R X E

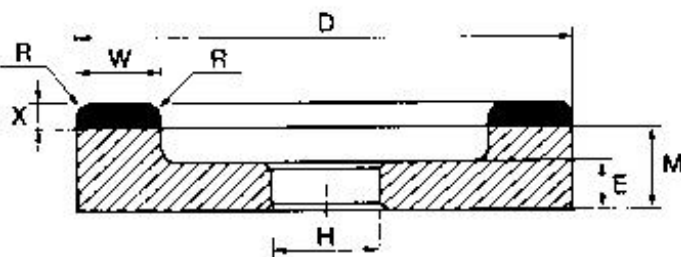
6L2

D M H W R X E

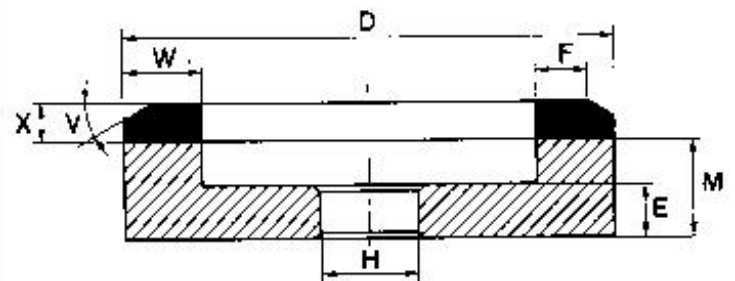
6M2

D M H W V X F E

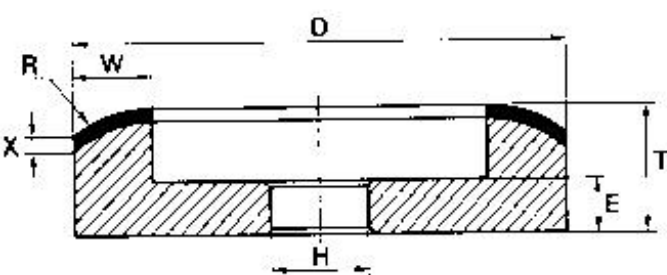
6P5

D T H W R X E

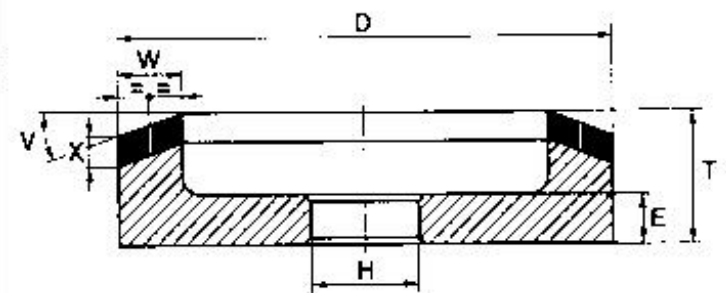
6VV5

D T H W V X E

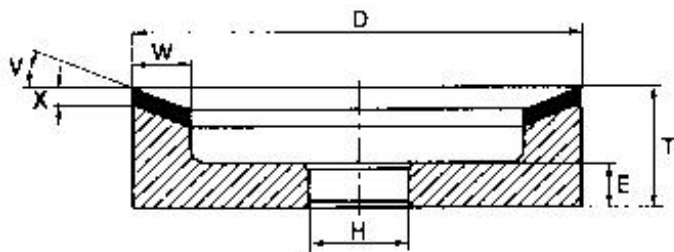
6V4

D	T	H	W	V	X	E
---	---	---	---	---	---	---

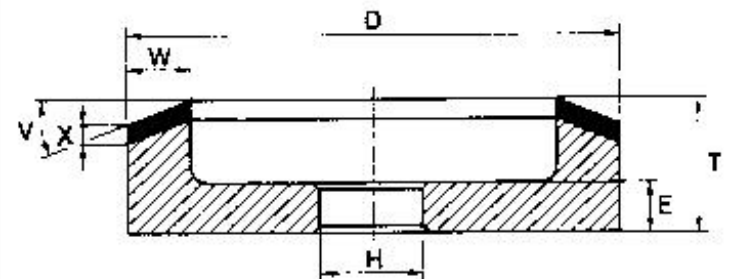
6V5

D	T	H	W	V	X	E
---	---	---	---	---	---	---

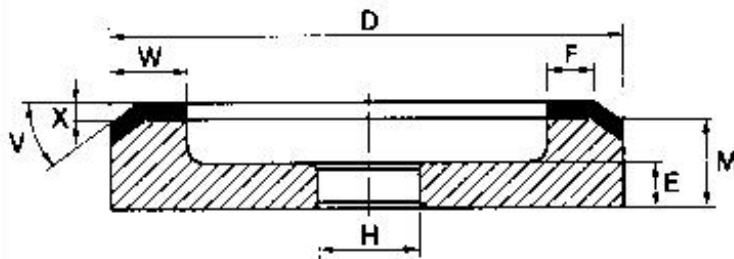
6Y2

D	M	H	W	V	X	F	E
---	---	---	---	---	---	---	---

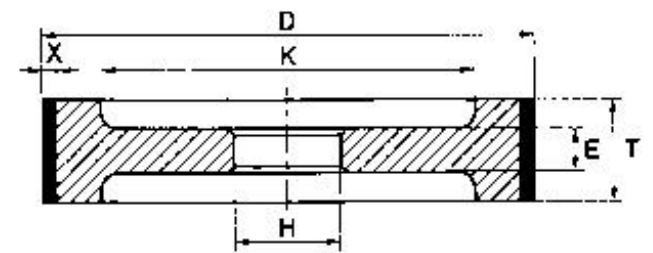
9A1

D	T	H	X	K	E
---	---	---	---	---	---

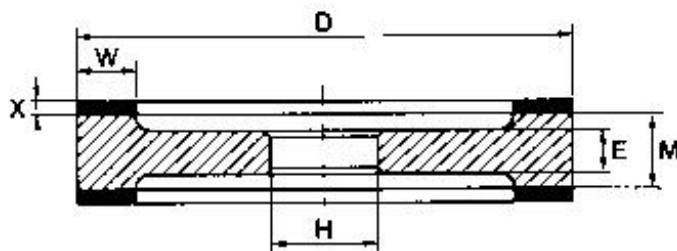
9A3

D	M	H	W	X	E
---	---	---	---	---	---

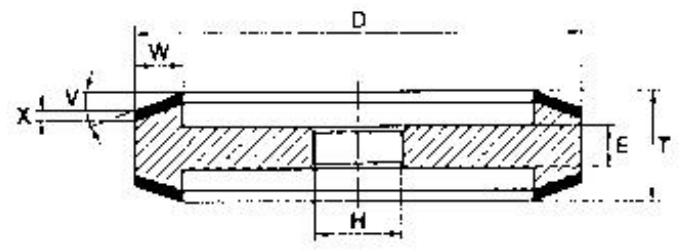
9V3

D	T	H	W	V	X	E
---	---	---	---	---	---	---

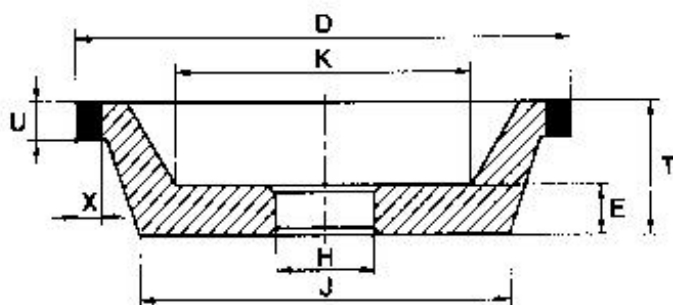
11A1

D	U	H	X	T	K	E	J
---	---	---	---	---	---	---	---

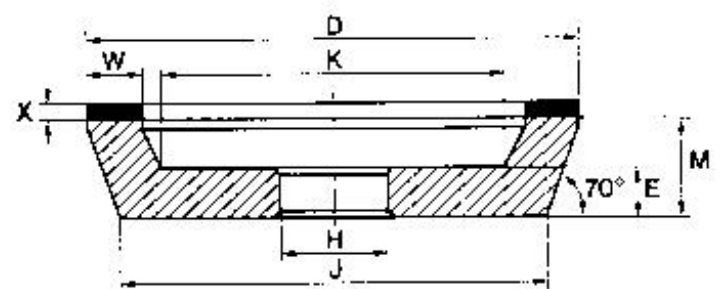
11A2-70°

D	M	H	W	X	K	E	J
---	---	---	---	---	---	---	---

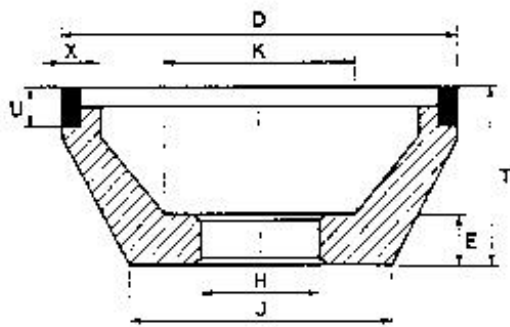
11A9

D T H U X K E J

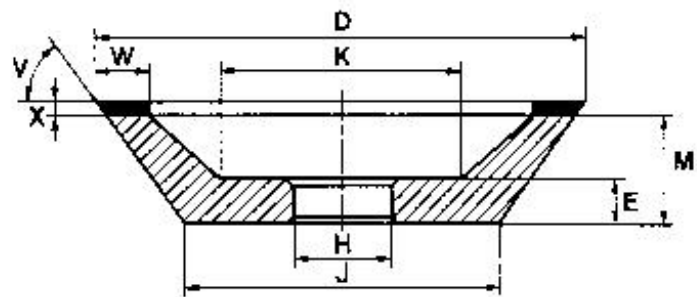
11B2

D M H W V X K E J

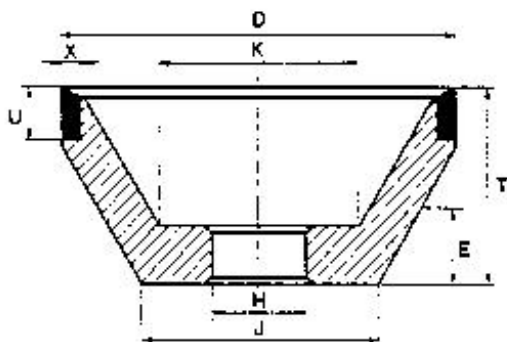
11B9

D T H U X K E J

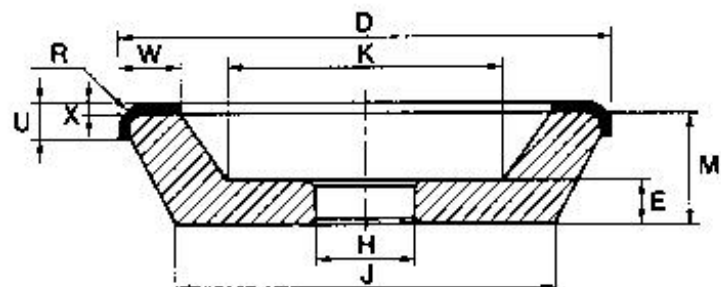
11CH9

D M H W U X R E K J

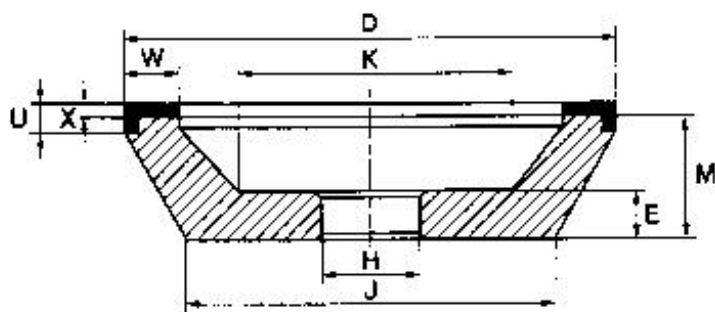
11C9

D M H W U X K E J

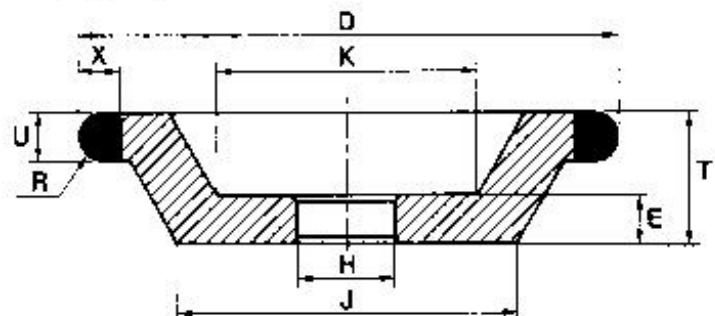
11F1

D U H R X T K E J

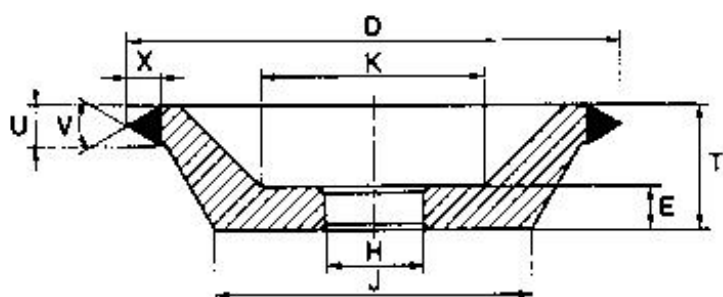
11K1

D U H V X T K E J

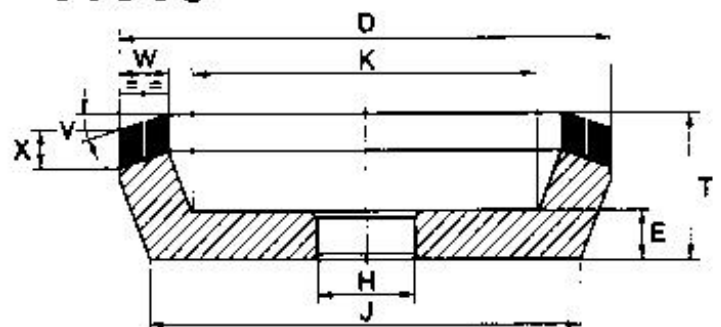
11V5

D T H W V X K E J

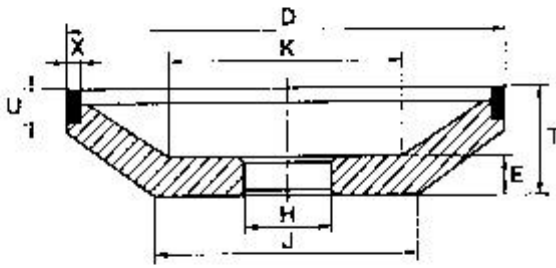
12A9

D T H U X K E J

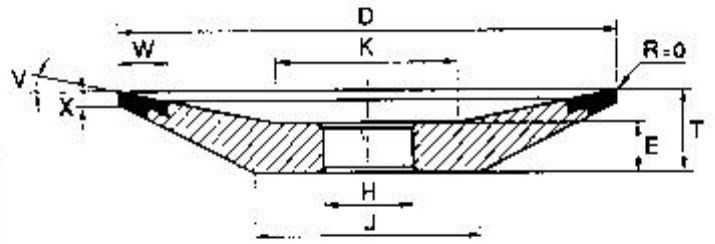
12BT9

D T H W V R X K E J

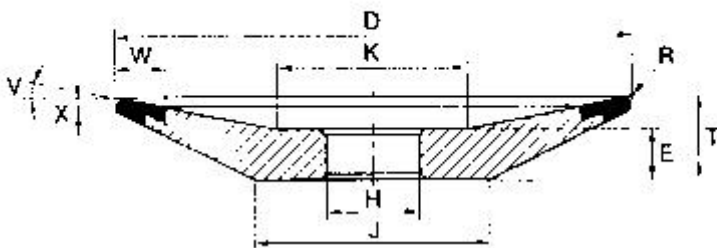
12BT9

D T H W V R X K E J

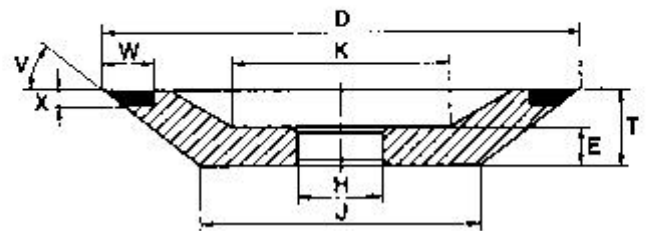
12B9

D T H W V X K E J

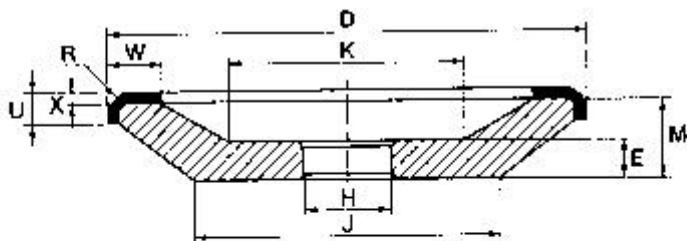
12CH9

D M H W U X R E K J

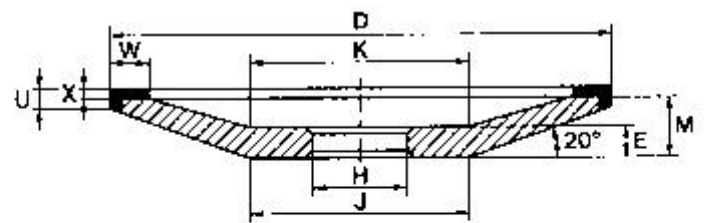
12C9-20°

D M H W U X K E J

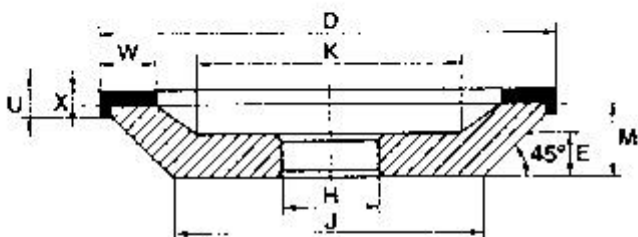
12C9-45°

D M H W U X K E J

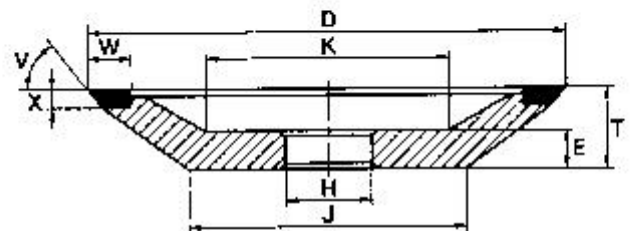
12ET9

D T H W V X K E J

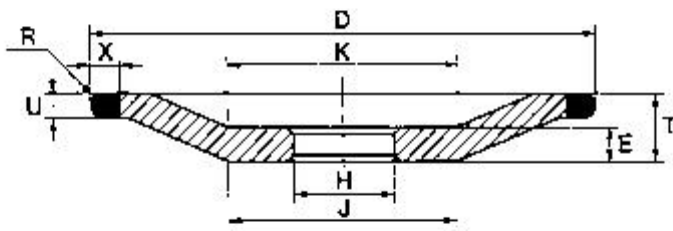
12F1

D U H R X T K E J

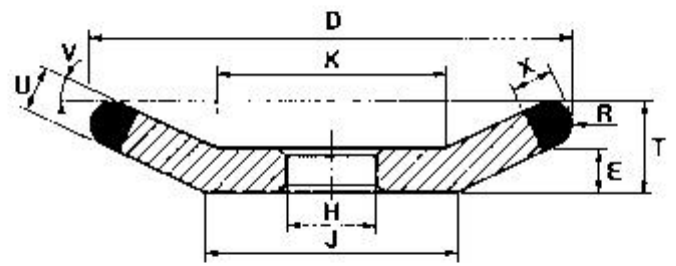
12F9

D U H R X T V E

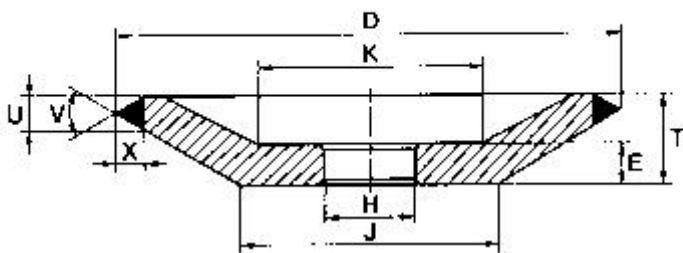
12K1

D U H T V X K E J

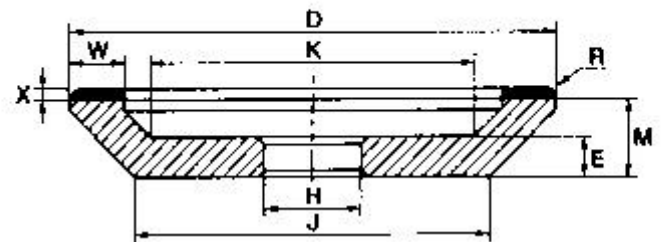
12Q2

D M H W X R K E J

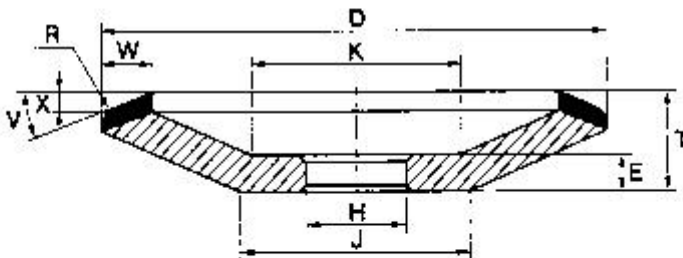
12Q5

D T H W V X R E K J

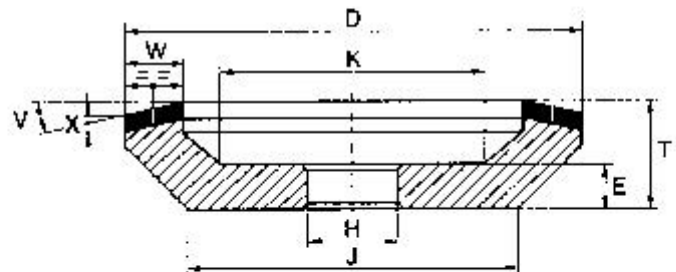
12V5

D T H W V X K E J

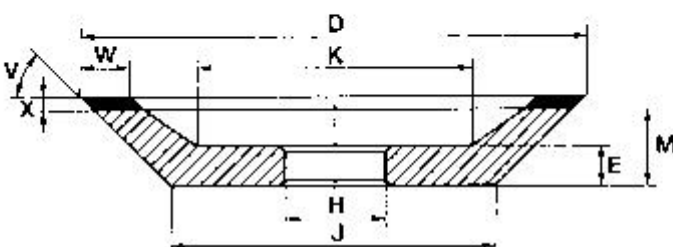
12V2

D M H W V X K E J

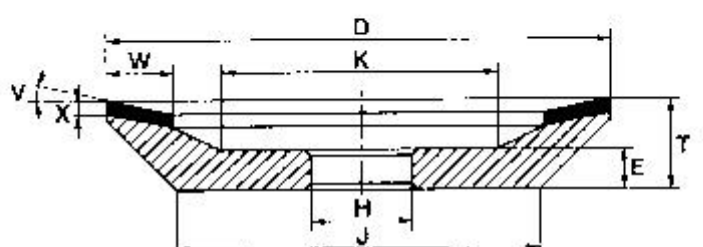
12V4

D T H W V X K E J

12V5

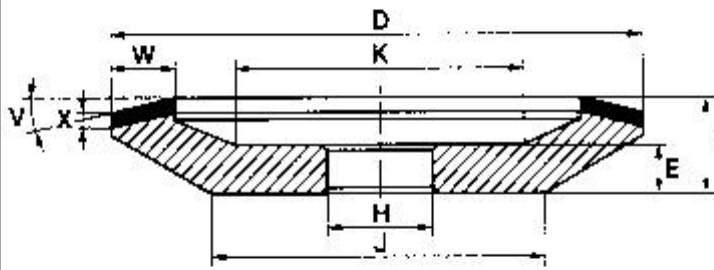

D	T	H	W	V	X	K	E	J
---	---	---	---	---	---	---	---	---

12V9

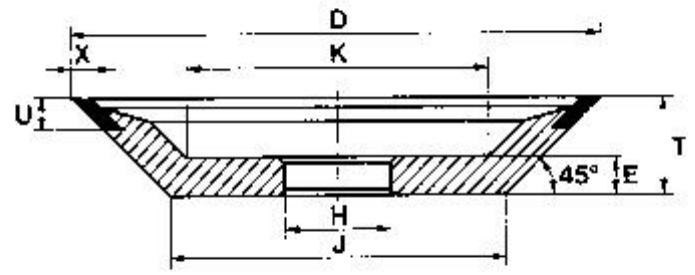

D	T	H	X	U	K	E	J
---	---	---	---	---	---	---	---

12Y9

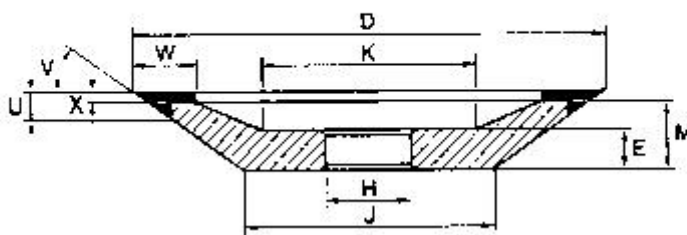

D	M	H	W	X	U	V	E	K	J
---	---	---	---	---	---	---	---	---	---

13A2

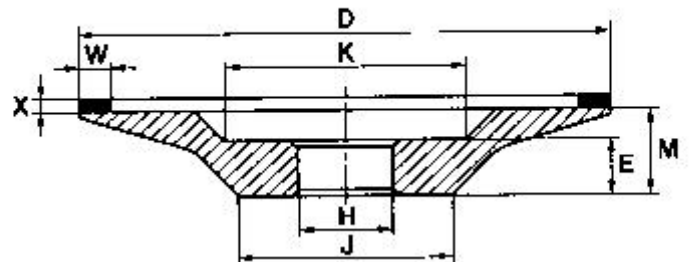

D	M	H	W	X	K	E	J
---	---	---	---	---	---	---	---

13C9

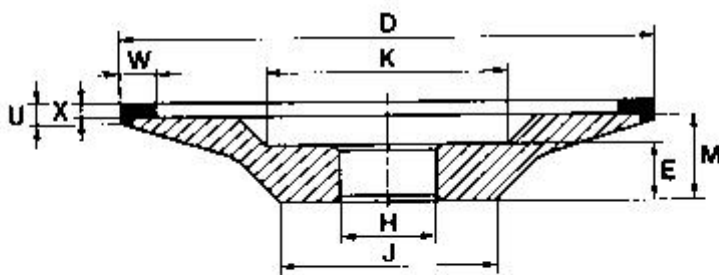

D	M	H	W	U	X	K	E	J
---	---	---	---	---	---	---	---	---

13ET9

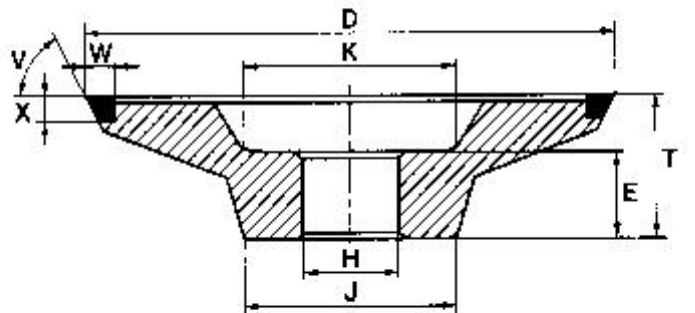

D	T	H	W	V	X	K	E	J
---	---	---	---	---	---	---	---	---

13V2

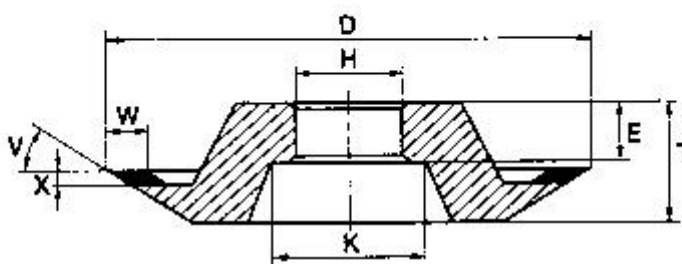

D	T	H	W	V	X	K	E
---	---	---	---	---	---	---	---

14A1

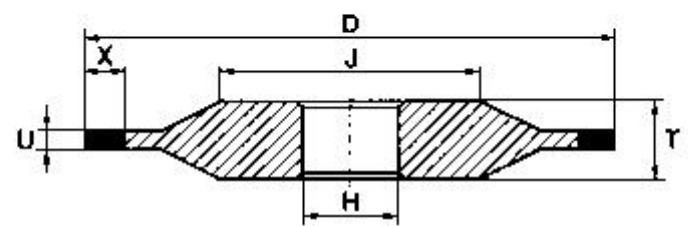

D	U	H	X	T	J
---	---	---	---	---	---

14A1R

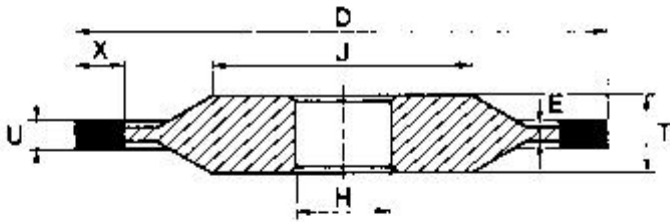

D	U	H	X	E	T	J
---	---	---	---	---	---	---

14B1

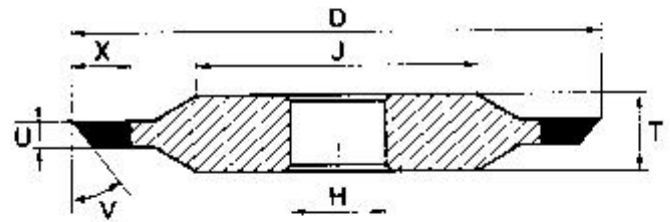

D	U	H	V	X	T	J
---	---	---	---	---	---	---

14C9

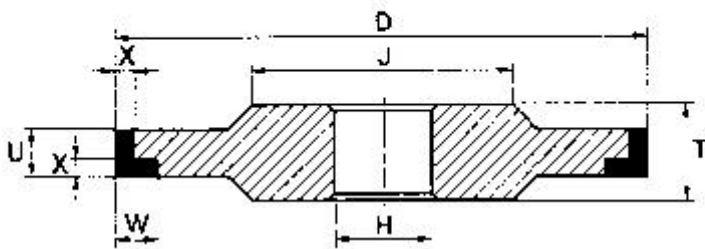

D	U	H	W	X	T	J
---	---	---	---	---	---	---

14EE1

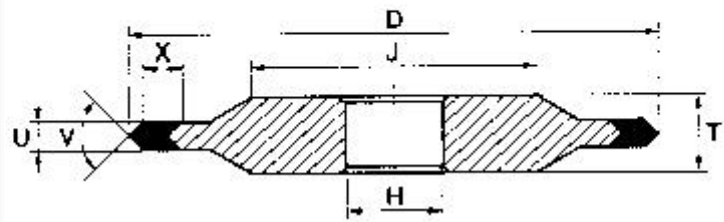

D	U	H	V	X	T	J
---	---	---	---	---	---	---

14ER1

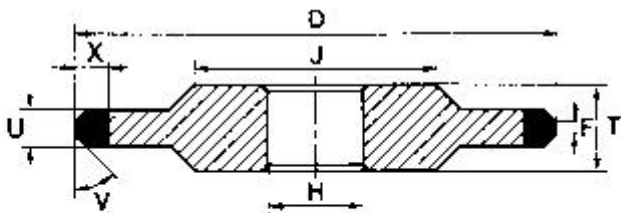

D	U	H	V	F	X	T	J
---	---	---	---	---	---	---	---

14E1

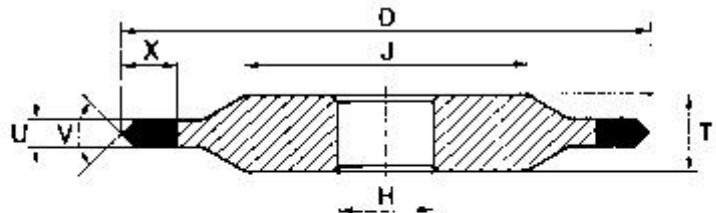

D	U	H	V	X	T	J
---	---	---	---	---	---	---

14E6Q

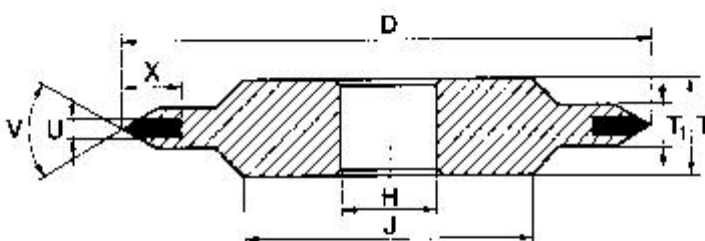

D	U	H	V	X	T	J	T ₁
---	---	---	---	---	---	---	----------------

14FF1

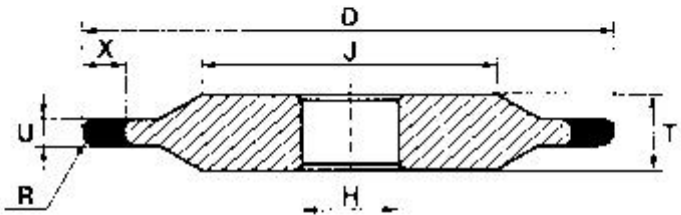

D	U	H	R	X	T	J
---	---	---	---	---	---	---

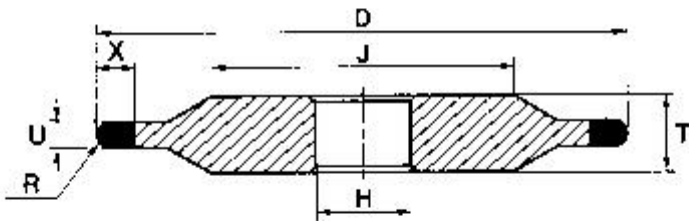
14F1

D	U	H	R	X	T	J
---	---	---	---	---	---	---

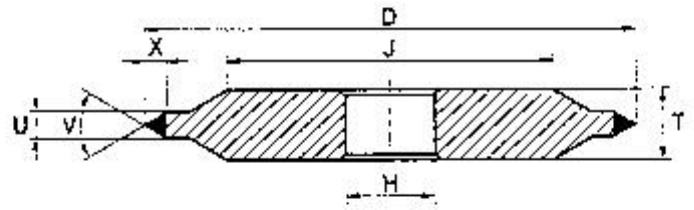
14K1

D	U	H	V	X	T	J
---	---	---	---	---	---	---

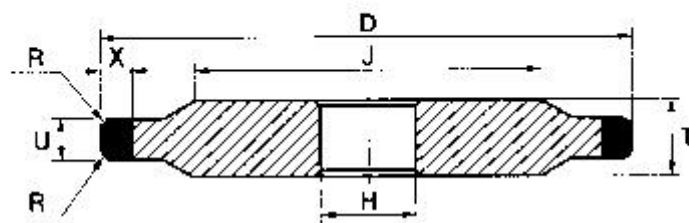
14L1

D	U	H	R	X	T	J
---	---	---	---	---	---	---

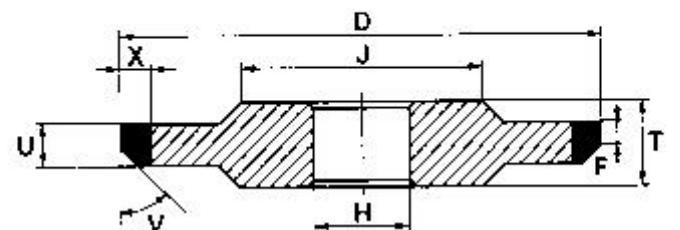
14M1

D	U	H	V	F	X	T	J
---	---	---	---	---	---	---	---

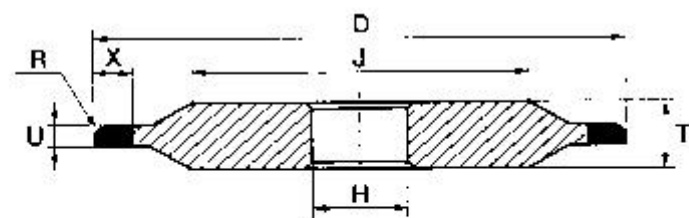
14Q1

D	U	H	R	X	T	J
---	---	---	---	---	---	---

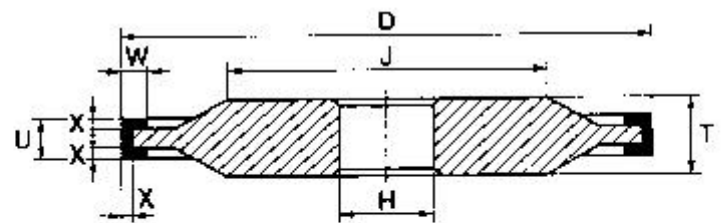
14U1

D	U	H	W	X	T	J
---	---	---	---	---	---	---

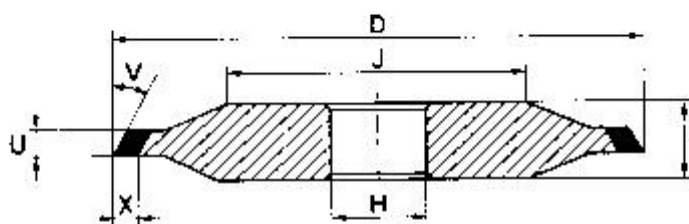
14V1

D	U	H	V	X	T	J
---	---	---	---	---	---	---

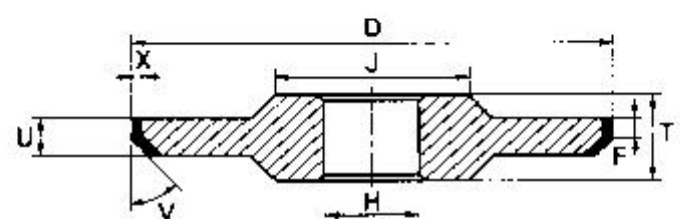
14Y1

D	U	H	V	F	X	T	J
---	---	---	---	---	---	---	---

15A2

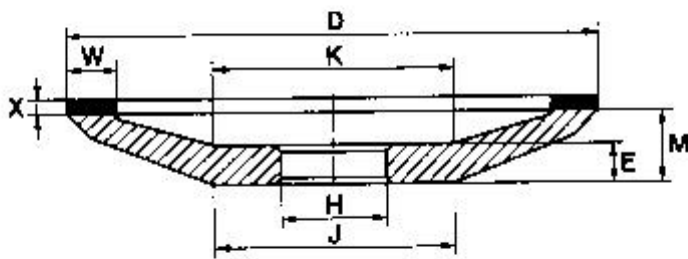

D	M	H	W	X	K	E	J
---	---	---	---	---	---	---	---

15C9

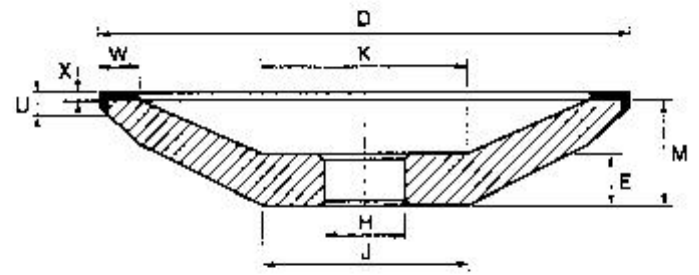

D	M	H	W	U	X	K	E	J
---	---	---	---	---	---	---	---	---

15V9

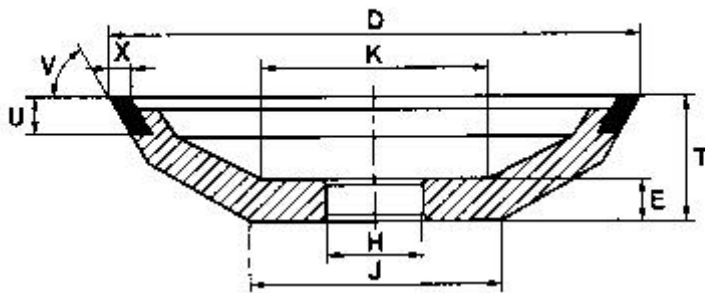

D	T	H	V	U	X	K	E	J
---	---	---	---	---	---	---	---	---

15Y9

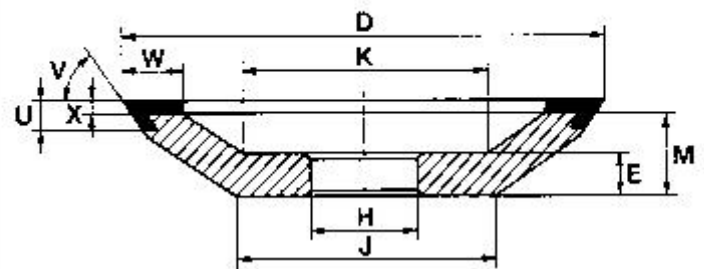

D	M	H	W	X	U	V	E	K	J
---	---	---	---	---	---	---	---	---	---

HH1



W	T	L	X
---	---	---	---

HHA

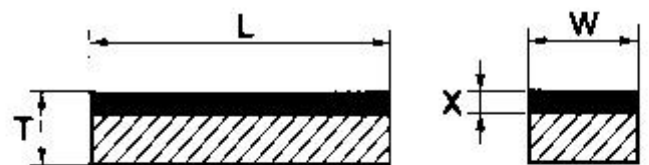

W	T	L	X
---	---	---	---

HHR



W	T	L	R	X
---	---	---	---	---

1A1W



D	T	X	Y	L
---	---	---	---	---

1A8W

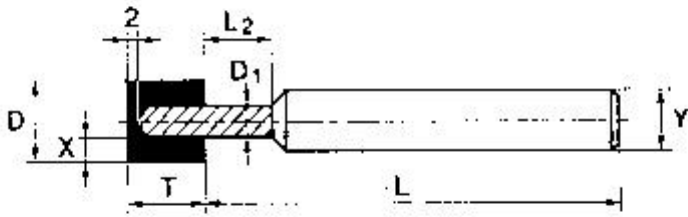

D	T	X	Y	L

1A8W

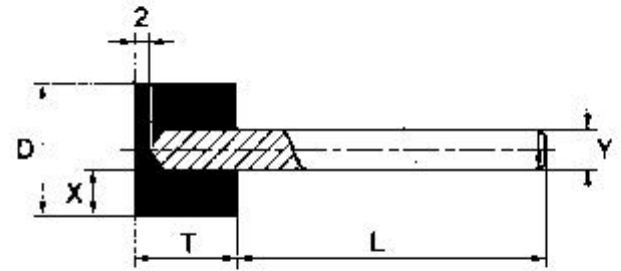

D	T	X	Y	L	D ₁	L ₂

1B1W

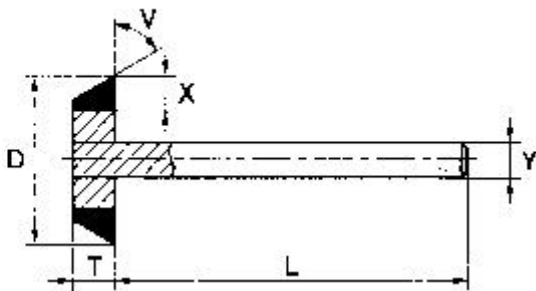

D	T	V	X	Y	L

1B8W

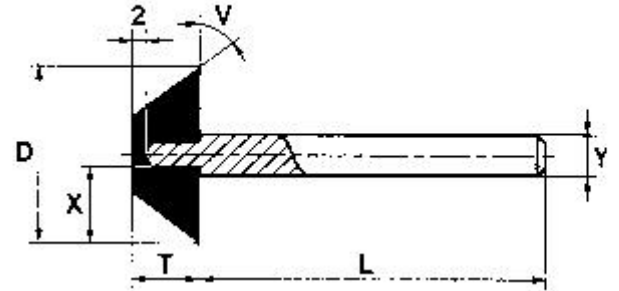

D	T	V	X	Y	L

1E8W

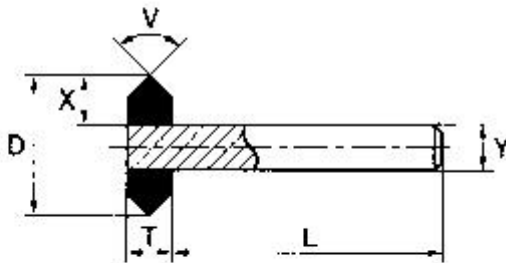

D	T	V	X	Y	L

1F1W

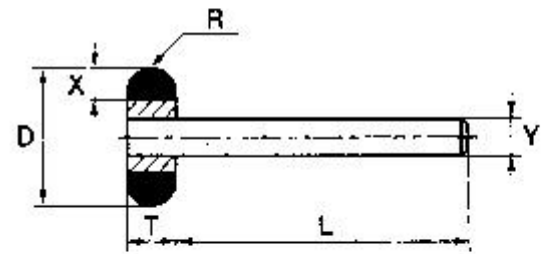

D	T	R	X	Y	L

3A1W

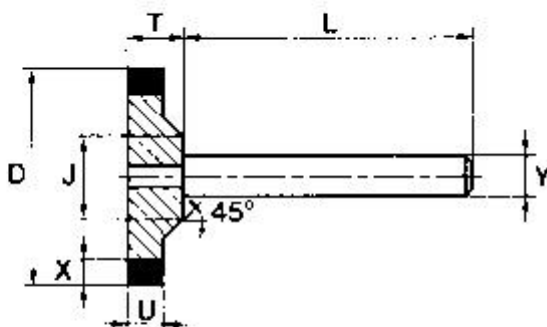

D	U	X	T	Y	L	J

3F1W

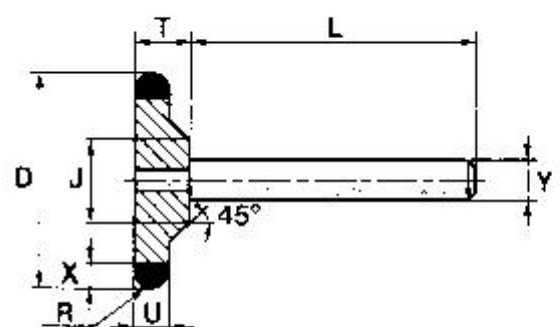

D	U	R	X	T	Y	L	J

6A2W

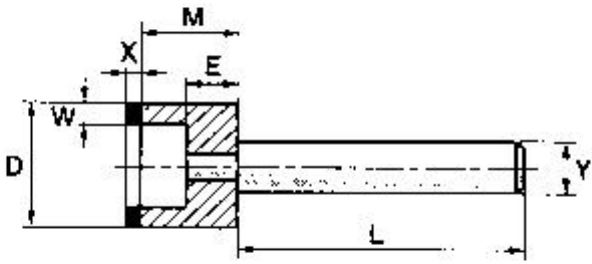

D	M	W	X	E	Y	L